

# Jansen-Economy 60 Türen

Türen aus Stahl

# Portes Jansen-Economy 60

Portes en acier

# Jansen-Economy 60 doors

Doors in steel



2	Systembeschreibung Description du système System description
4	Leistungseigenschaften Caractéristiques de performance Performance characteristics
5	Merkmale Caractéristiques Features
8	Typenübersicht Sommaire des types Summary of types
10	Profile Profilés Profiles
12	Prinzip-Schnittpunkt Principe de coupe de détail Principle section detail
13	Schnittpunkte Coupe de détails Section details
19	$U_f$ Werte nach EN 10077-2 Valeurs $U_f$ selon EN 10077-2 $U_f$ values according to 10077-2
21	Leistungswerte Valeurs de performance Performance values

# Systembeschreibung

## Description du système

## System description

### **Jansen-Economy 60: das Profilsystem für grosse, flächenbündige Türkonstruktionen.**

Mit einer Wandstärke von 1,75 mm eignet sich dieses Profilsystem mit Bauhöhe 60 mm ganz besonders für grosse, ein- und zweiflügelige Türkonstruktionen sowie Festverglasungen.

Optisch besonders reizvoll: die innen und aussen umlaufende Schattenfuge, die den Türkonstruktionen ihr ansprechendes Erscheinungsbild verleiht.

Die einfachen Profilformen gestatten eine rationelle Fertigung der soliden Türkonstruktionen.

Türflügel mit doppelten Anschlagdichtungen; im Schwellenbereich je nach Ausführung automatische Senkdichtung oder Anschlagdichtung. Speziell geeignet für den Einbau verdeckt liegender Türschliesser.

Das Erscheinungsbild der flächenbündigen Jansen-Economy 60 Türen ist deckungsgleich mit den ebenfalls flächenbündigen, wärmegeprägten Janisol Türen und Janisol 2 EI30 Brandschutztüren.

### **Jansen-Economy 60: le système de profilés pour constructions élégantes de portes à fleur de grandes dimensions.**

Avec une épaisseur de paroi de 1,75 mm, ce système de profilés (hauteur de construction de 60 mm) convient particulièrement aux constructions de portes de grandes dimensions à un et deux vantaux ainsi qu'aux vitrage fixes.

Particulièrement esthétique: la rainure négative sur le pourtour à l'intérieur comme à l'extérieur qui confère aux constructions de porte leur aspect agréable. Les formes simples des profilés permettent une fabrication rationnelle de portes robustes.

Vantaux de porte avec joints de battement doubles; dans la zone du seuil: joint seuil automatique ou joint de battement selon l'exécution. Particulièrement approprié à la pose de ferme-porte incorporé invisible.

L'aspect des portes à fleur Jansen-Economy 60 est identique à celui des portes Janisol à rupture de pont thermique également à fleur et des portes coupe-feu Janisol 2 EI30.

### **Jansen-Economy 60: the profile system for elegant flush construction of large door.**

With a wall thickness of 1.75 mm and a section depth of just 60 mm, this profile system is ideal for large single and double leaf doors and fixed glazing.

What makes the system particularly pleasing to the eye is the rebate running around the door both inside and out, giving the door its attractive appearance. The simple profile shapes allow cost efficient manufacture of solid door constructions.

Door leaves have dual rebate seals, and the threshold can be constructed with an automatic drop seal or rebate seal. Specially suitable for fitting concealed door closers.



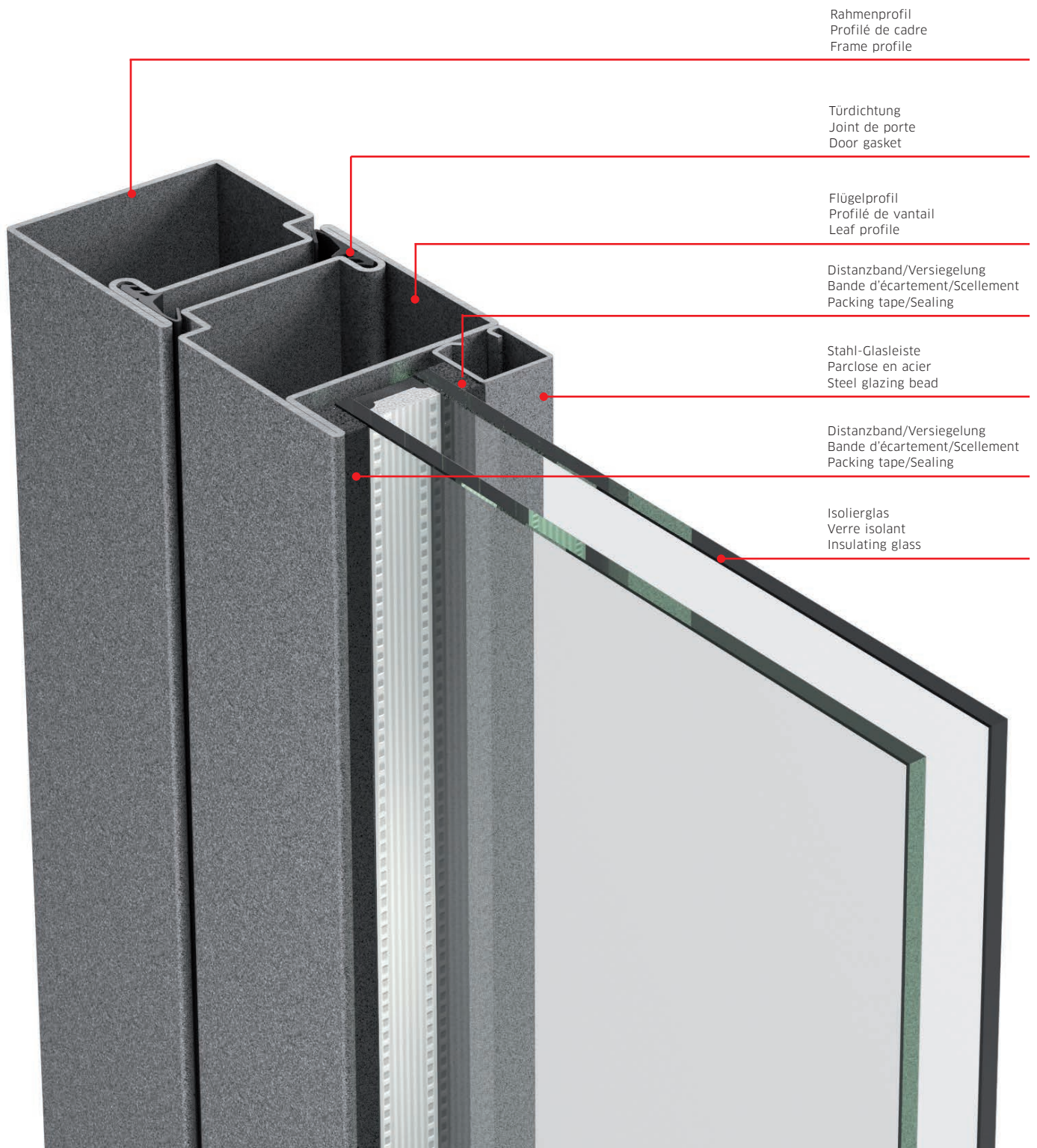

The flush fitting Jansen-Economy 60 door profile is very similar in appearance to the Janisol thermally insulated profile and the Janisol 2 EI30 thermally insulated fire door profile.





# Leistungseigenschaften Caractéristiques de performance Performance characteristics

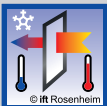

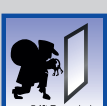
Prüfungen Essais Tests	Norm	Werte Valeurs Values	
Schlagregendichtheit Etanchéité à la pluie battante Watertightness	<b>EN 12208</b>	bis Klasse 5A jusqu'à Classe 5A up to Class 5A	
Widerstand bei Windlast Résistance à la pression du vent Resistance to wind load	<b>EN 12210</b>	bis Klasse C5 jusqu'à Classe C5 up to Class C5	
Luftdurchlässigkeit Perméabilité à l'air Air permeability	<b>EN 12207</b>	bis Klasse 4 jusqu'à Classe 4 up to Class 4	
Wärmedurchgangskoeffizient Transmission thermique Thermal production	<b>EN ISO 10077-1</b>	ab $U_f > 5,1 \text{ W/m}^2\text{K}$ dès $U_f > 5,1 \text{ W/m}^2\text{K}$ from $U_f > 5,1 \text{ W/m}^2\text{K}$	
Schallschutz Isolation phonique Sound insulation	<b>EN ISO 140-3</b>	bis $R_w$ 45 dB jusqu'à $R_w$ 45 dB up to $R_w$ 45 dB	
Durchschusshemmung Résistance aux balles Bullet proofing	<b>EN 1522/1523</b>	FB4 NS FB5 S/NS FB6 S/NS*	
Einbruchhemmung Anti-effraction Burglar resistance	<b>EN 1627</b>	RC1 - RC3	
Klassifizierung der Festigkeitsanforderungen Classification des exigences de résistance mécanique Classification of strength requirements	<b>EN 1192</b>	Klasse 4 Classe 4 Class 4	
Bedienungskräfte Forces de manœuvre Operating forces	<b>EN 12217</b>	Klasse 2 Classe 2 Class 2	
Tragfähigkeit von Sicherheitsvorrichtungen Capacité du dispositif de sécurité Load bearing capacity of safety devices	<b>EN 948</b>	Anforderung erfüllt Exigence remplie Requirement satisfied	

\* Sonderkonstruktion

\* Construction spéciale

\* Special construction



# Merkmale

## Caractéristiques

## Characteristics

### **Einbruchhemmung RC3**

Die vom Institut für Fenstertechnik (ift) Rosenheim erfolgreich geprüften Stahlprofilssysteme lassen sich mit Mehrfachverriegelungsbeschlägen bis zu RC3 Türen ausstatten, ohne das äussere Erscheinungsbild zu beeinträchtigen. Die einbruchhemmenden Komponenten fügen sich harmonisch in die Stahlprofilssysteme ein.

### **Integrierte Türschliesser**

Die integrierten Türschliesser mit Gleitschienen wie zum Beispiel ITS 96 und GEZE Boxer können kompakt und unsichtbar in die Jansen-Economy Türen eingebaut werden. Schliesskraft, Schliessgeschwindigkeit und Endschlag sind stufenlos einstellbar; die Öffnungsbegrenzung bis max. 120° lässt sich mechanisch dämpfen. Diese hochwertigen Türschliesser eignen sich für Jansen-Economy 60 Türen mit einem Flügelgewicht bis 180 kg.

### **Fluchttürsysteme**

Für Fluchttürsysteme gelten einheitliche Normen und Richtlinien bezüglich Ausstattung mit Beschlägen. Ihr wesentliches Merkmal ist die gemeinsame Prüfung von Schloss, Schliessblech und Beschlagszubehör. Sowohl Notausgänge als auch Paniktüren dürfen nur noch mit einheitlich geprüften Verschlussystemen ausgestattet werden. Jansen Panikbeschläge erfüllen die beiden Fluchttürnormen EN 179 für Notausgangverschlüsse und EN 1125 für Paniktürverschlüsse.

### **Protection anti-effraction RC3**

Les systèmes de profilés en acier contrôlés avec succès par l'institut allemand des technologies de fenêtres (ift) de Rosenheim peuvent être équipés de ferrures pour verrouillage multiple jusqu'aux portes RC3 sans que leur apparence en soit altérée. Les composants anti-effraction s'harmonisent parfaitement avec les systèmes de profilés en acier.

### **Ferme-portes intégrés**

Les ferme-portes automatiques intégrés à glissières tels que ITS 96 et Geze Boxer, compacts, peuvent être intégrés de manière invisible dans les portes Jansen-Economy. La force de fermeture, la vitesse de fermeture et la butée sont réglables en continu; la limitation d'ouverture à 120° max. peut être amortie mécaniquement. Ces ferme-portes de grande qualité sont compatibles avec les portes Jansen-Economy 60 d'un poids du vantail jusqu'à 180 kg.

### **Systèmes de porte de secours**

Des normes standardisées relatives à l'équipement avec ferrures sont applicables aux systèmes de porte de secours. Leur caractéristique essentielle est le contrôle commun de la serrure, de la gâche et des accessoires de montage. Tant les sorties de secours que les portes panique doivent être impérativement équipées de systèmes de fermeture standardisés et contrôlés. Les ferrures panique Jansen répondent aux deux normes relatives aux portes de secours: EN 179 pour les fermetures des sorties de secours et EN 1125 pour les fermetures de portes panique.

### **Burglar resistance RC3**

The steel profile systems have been successfully tested by the Institute for Window Technology (ift) in Rosenheim and can be fitted with multi-point locking for doors up to RC3 without affecting the external appearance of the door. The burglar-resistant components can be incorporated seamlessly into the steel profile systems.

### **Integrated door closers**

The integrated door closers with slide rails, such as the ITS 96 and Geze Boxer, can be installed in the Jansen-Economy doors in a compact and concealed fashion. The closing force, closing speed and end stop are infinitely adjustable, and the opening restriction up to max. 120° can be damped mechanically. These high-quality door closers are suitable for Jansen-Economy 60 doors with a leaf weight of up to 180 kg.

### **Emergency exit systems**

Emergency exit systems are regulated by a uniform set of standards and guidelines with regard to fittings. The main feature of these standards is the combined testing of lock, strike plate and fittings accessories. Emergency exits and panic doors may only be fitted with lock systems that have been uniformly tested. Jansen panic fittings conform to both emergency door standards EN 179 for emergency exit devices and EN 1125 for panic exit devices.



### Fingerschutztüren

Die gerundeten Halbschalen minimieren die Verletzungsgefahr bei der Nebenschliesskante. So können Quetsch- und Scherstellen nach DIN 18650 vermieden werden. Dank wartungsarmer, hochleistungsfähiger Bandlager eignet sich die Jansen-Economy-Fingerschutztüre besonders für Gebäude mit starkem Publikumsverkehr wie Einkaufszentren, Schulen oder Krankenhäuser. Die Fingerschutztüre erfüllt die Produktnorm EN 14351-1 und ist CE zertifiziert. Die Fingerschutztüren sind kompatibel mit dem Jansen-Economy 60 Profilsortiment. Zudem können integrierte Türschliesser und automatische Drehtürantriebe eingebaut werden.

### Portes anti-pince-doigts

Les demi-coquilles arrondies réduisent le risque de blessures au niveau du champ de fermeture secondaire. Des points d'écrasement et de cisaillement peuvent ainsi être évités selon la norme DIN 18650. Grâce à son palier de paumelle très performant ne nécessitant que peu de maintenance, la porte anti-pince-doigts convient particulièrement aux bâtiments ouverts à un vaste public tels que les centres commerciaux, les écoles ou les hôpitaux. La porte anti-pince-doigts satisfait à la norme produit EN 14351-1 pour portes ouvrant vers l'extérieur, elle est certifiée CE. Les portes anti-pince-doigts sont compatibles avec la gamme de profilés Jansen-Economy 60. Il est en outre possible de monter des ferme-portes automatiques intégrés et des commandes automatiques pour portes à la française.

### Anti-finger-trap doors

The rounded half profiles minimise the risk of injury at the secondary closing edge. This allows crushing and shearing points to be eliminated in accordance with DIN 18650. With low-maintenance, high-performance hinge bushes, the Jansen-Economy 60 anti-finger-trap door is particularly suitable for busy public buildings, such as shopping centres, schools or hospitals. The Jansen-Economy 60 anti-finger-trap door meets the product standard EN 14351-1 for external doors and is CE certified. The anti-finger-trap doors are compatible with the Jansen-Economy 60 profile range. Integrated door closers and automatic side-hung door drives can also be installed.

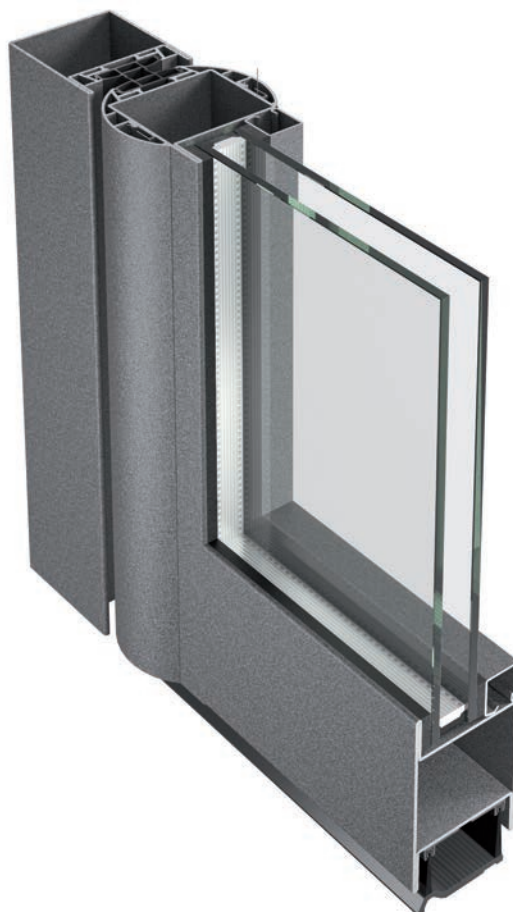

# Typenübersicht

## Sommaire des types

### Summary of types

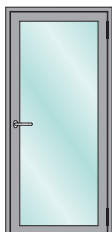

Einflügelige Türe  
Porte à un vantail  
Single-leafed door

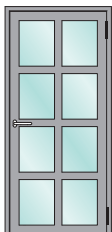

Einflügelige Türe mit Sprossen  
Porte à un vantail avec traverses  
Single-leafed door with transoms

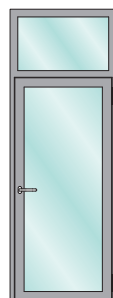

Einflügelige Türe mit Oberlicht  
Porte à un vantail avec imposte  
Single-leafed door with top light

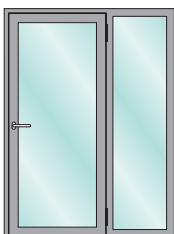

Einflügelige Türe mit Seitenteil  
Porte à un vantail avec partie latérale  
Single-leafed door with side light

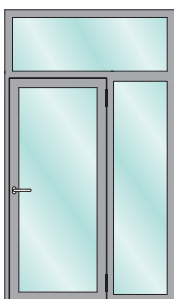

Einflügelige Türe mit Seitenteil und Oberlicht  
Porte à un vantail avec avec partie latérale et imposte  
Single-leafed door with side light and top light

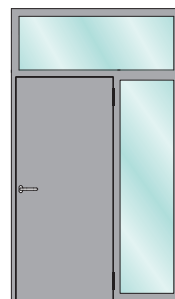

Verblechte Türe mit Seitenteil und Oberlicht  
Porte entièrement tôlée à un vantail avec partie latérale et imposte  
Sheet metal clad door with side light and top light

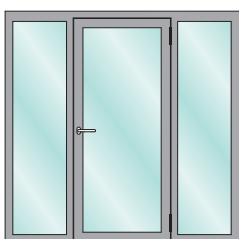

Einflügelige Türe mit zwei Seitenteilen  
Porte à un vantail avec deux parties latérales  
Single-leafed door with two side lights

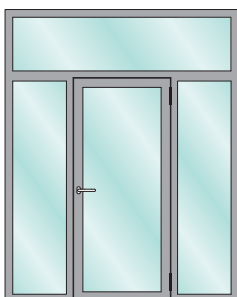

Einflügelige Türe mit zwei Seitenteilen und Oberlicht  
Porte à un vantail avec deux parties latérales et imposte  
Single-leafed door with two side lights and top light

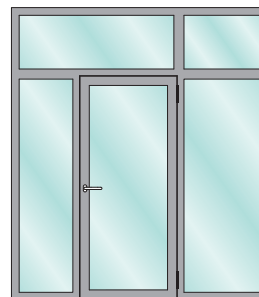

Einflügelige Türe mit Seitenteil und Oberlicht  
Porte à un vantail avec partie latérale et imposte  
Single-leafed door with two side light and top light

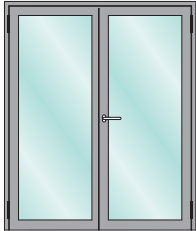

Zweiflügelige Türe  
Porte à deux vantaux  
Double-leafed door

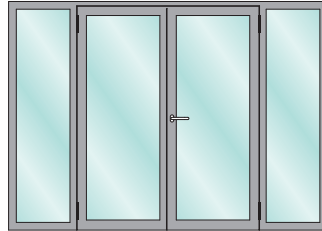

Zweiflügelige Türe mit Seitenteilen  
Porte à deux vantaux avec parties latérales  
Double-leafed door with side lights

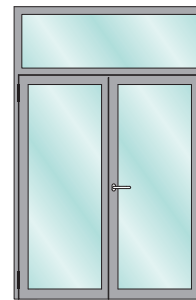

Zweiflügelige Türe mit Oberlicht  
Porte à deux vantaux avec imposte  
Double-leafed door with top light

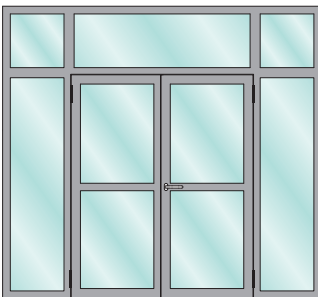

Zweiflügelige Türe mit Seitenteilen  
und Oberlichtern  
Porte à deux vantaux avec parties latérales  
et impostes  
Double-leafed door with side lights and  
top lights

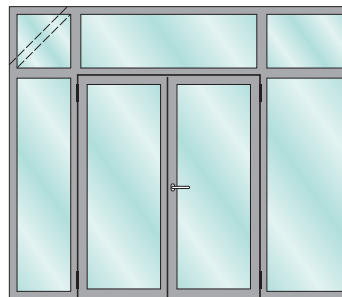

Zweiflügelige Türe mit Seitenteil und Oberlicht  
Porte à deux vantaux avec partie  
latérale et imposte  
Double-leafed door with side light and  
top light

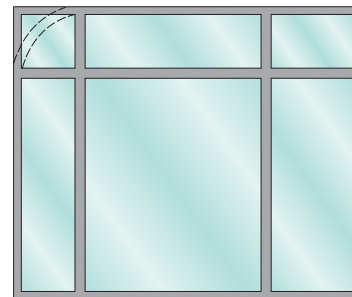

Festverglasung  
Vitrage fixe  
Fixed glazing



Zweiflügelige Türe mit Rundbogen-Oberlicht  
Porte à deux vantaux avec imposte demi-ronde  
Double-leafed door with round arched top light

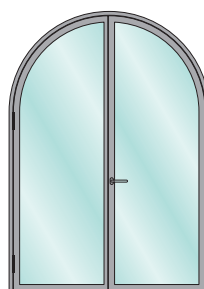

Zweiflügelige Bogentüre  
Porte cintrée à deux vantaux  
Double-leafed arched door

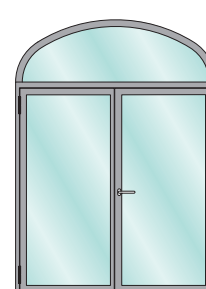

Zweiflügelige Türe mit Korbbogen-Oberlicht  
Porte à deux vantaux avec imposte fixe  
Double-leafed door with oval arched top light

**Empfehlung:**  
**Max. Grössen und max. Gewicht für Türen:**

Flügelbreite	1300 mm
Flügelhöhe	3000 mm
Flügelgewicht	230 kg (2,3 kN)

**Recommandation:**  
**Dimensions et poids max. pour portes:**

Largeur du vantail	1300 mm
Hauteur du vantail	3000 mm
Poids du vantail	230 kg (2,3 kN)

**Recommandation:**  
**Maximum size and weight of doors:**

Leaf width	1300 mm
Leaf height	3000 mm
Leaf weight	230 kg (2,3 kN)

# Profile Profilés Profiles

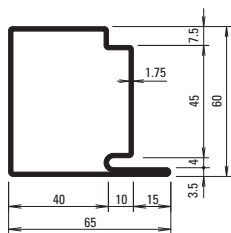

30.019  
 30.019 Z

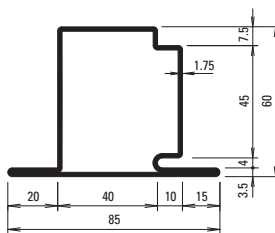

30.119  
 30.119 Z

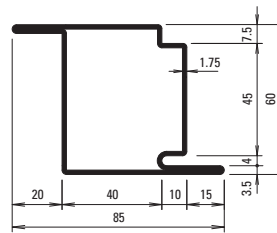

30.419  
 30.419 Z

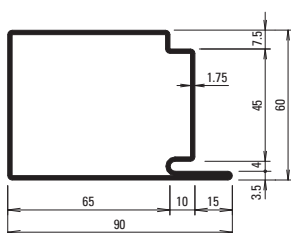

30.017  
 30.017 Z

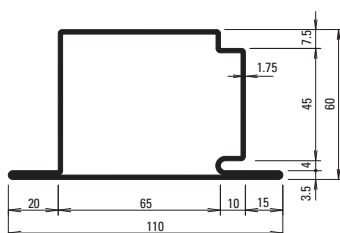

30.117  
 30.117 GV+GC

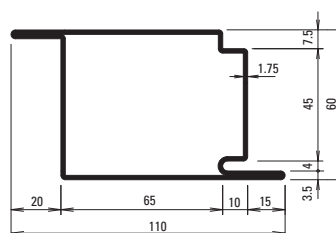

30.415  
 30.415 GV+GC

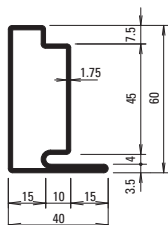

30.018  
 30.018 Z

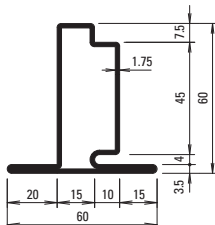

30.118  
 30.118 Z

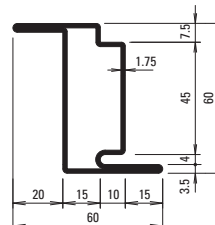

30.418  
 30.418 Z

## Oberfläche

Artikel-Nr.

ohne Zusatz = blank

mit Z =

aus feuerverzinktem Bandstahl

mit GV+GC =

aussen galvanisch verzinkt und  
 gelbchromatiert

## Surface

No. d'article

sans supplément = brut

avec Z =

en bandes d'acier zinguées au feu

avec GV+GC =

zingués galvanique à l'extérieur et  
 chromatisé jaune

## Surface

Part no.

without addition = bright

with Z =

made from hot-dip galvanised strip

with GV+GC =

outside galvanised and yellow  
 chromated

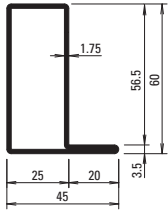

01.634  
01.634 Z

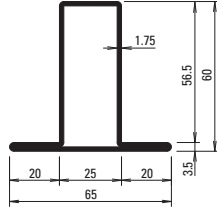

02.634  
02.634 Z

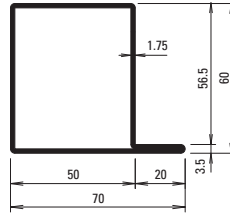

01.684  
01.684 Z

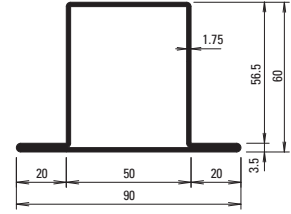

02.684  
02.684 Z

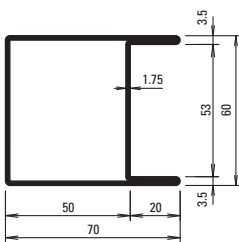

04.637  
04.637 Z

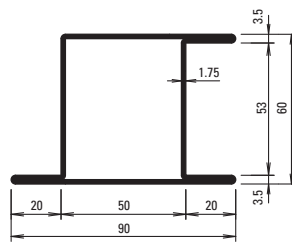

05.637  
05.637 Z

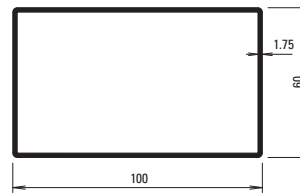

400.051  
400.051 GV+GC

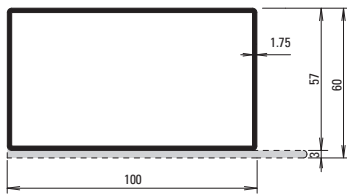

400.050  
400.050 GV+GC

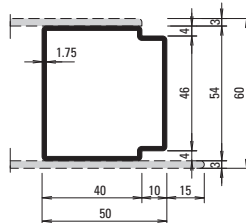

81.010  
81.010 GV+GC

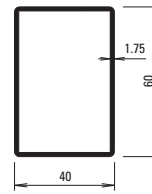

400.052  
400.052 GV+GC

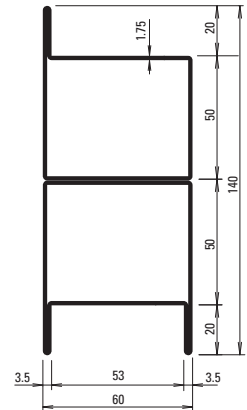

05.001

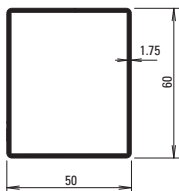

400.054  
400.054 GV+GC

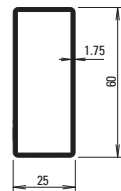

400.055  
400.055 GV+GC

Profile im Masstab 1:3  
 Profilés à l'échelle 1:3  
 Profiles on scale 1:3

Prinzip-Schnittpunkte  
 Principe de coupe de détails  
 Principle section details

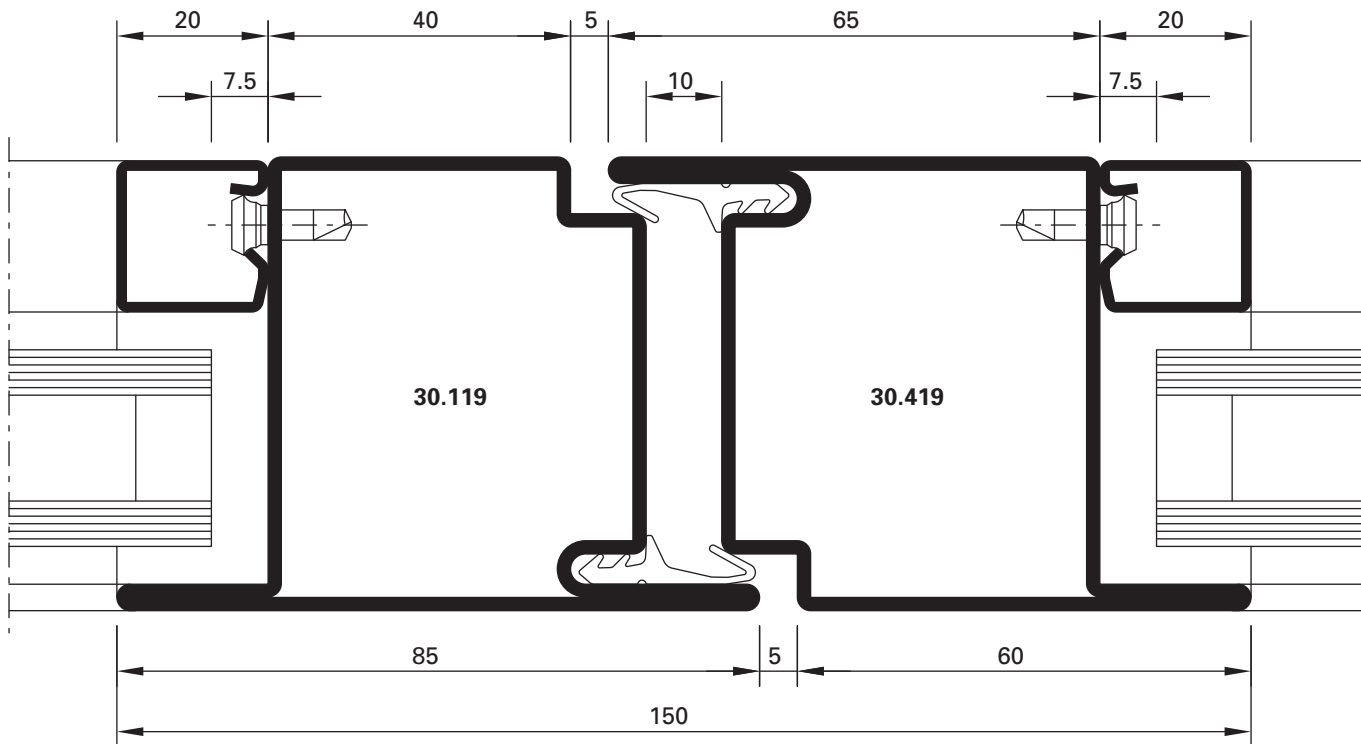
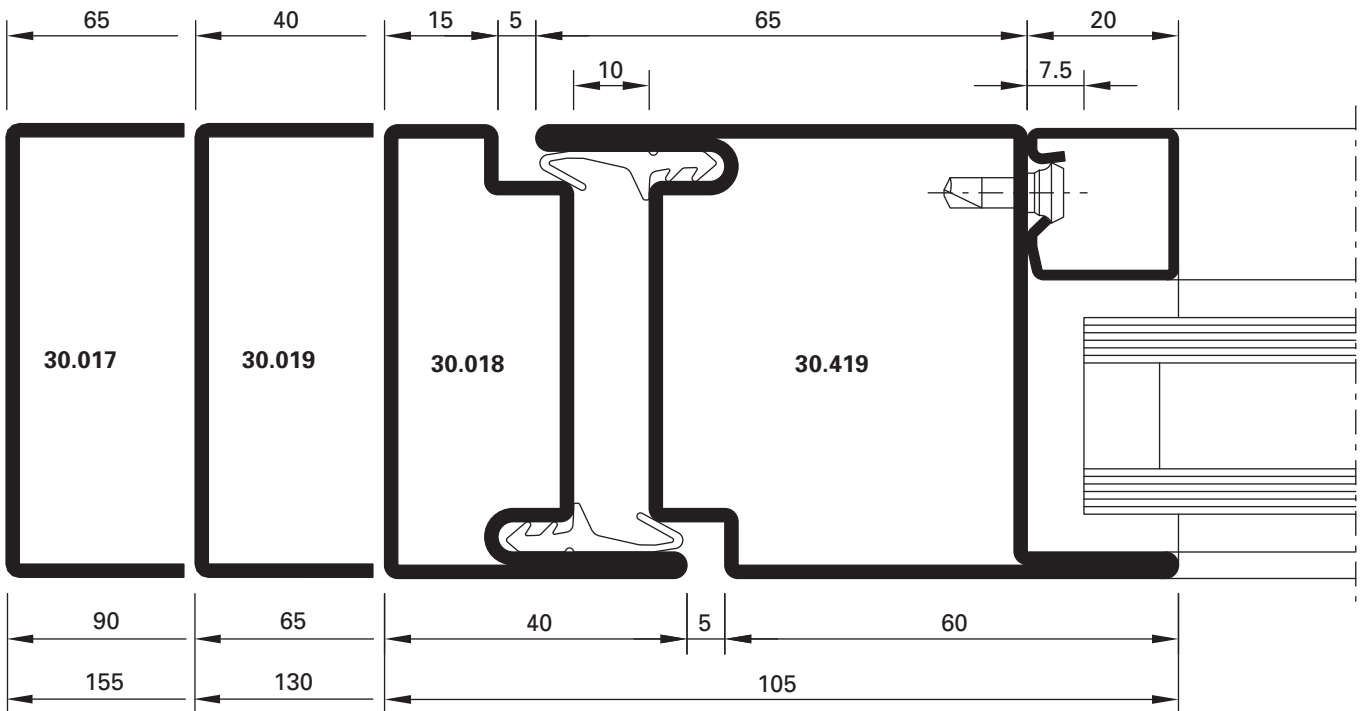

Auf diesen Seiten zeigen wir lediglich eine Übersicht der technischen Details. Weitere Informationen finden Sie unter [jansen.com/architektur-katalog](http://jansen.com/architektur-katalog)

Nous ne montrons qu'un aperçu des détails techniques sur cette page. De plus amples informations sont données sur le site [jansen.com/catalogue-architecture](http://jansen.com/catalogue-architecture)

These pages only contain an overview of the technical details. For more information, visit [jansen.com/architecture-catalogue](http://jansen.com/architecture-catalogue)

# Schnittpunkte Coupe de détails Section details

Schnittpunkte im Masstab 1:1  
Coupe de détails à l'échelle 1:1  
Section details on scale 1:1

Jansen-Economy 60 Türen  
Jansen-Economy 60 portes  
Jansen-Economy 60 doors

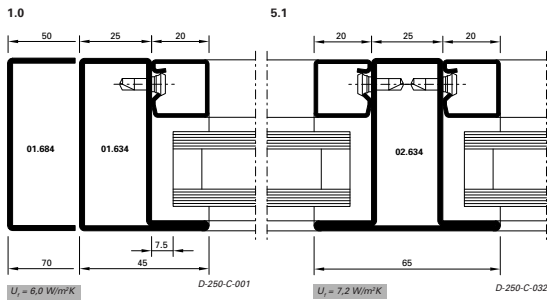
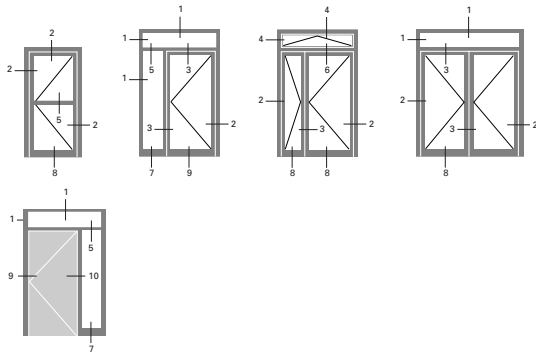

A-62-18

01/2014

**JANSEN**

Schnittpunkte im Masstab 1:1  
Coupe de détails à l'échelle 1:1  
Section details on scale 1:1

Jansen-Economy 60 Türen  
Jansen-Economy 60 portes  
Jansen-Economy 60 doors

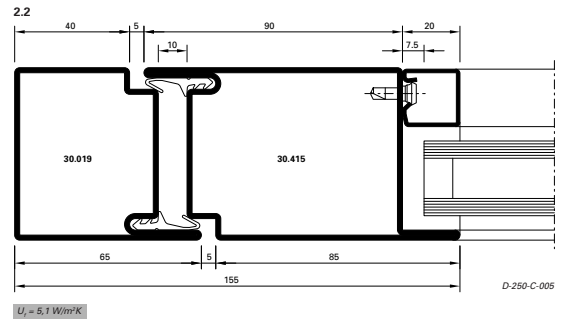
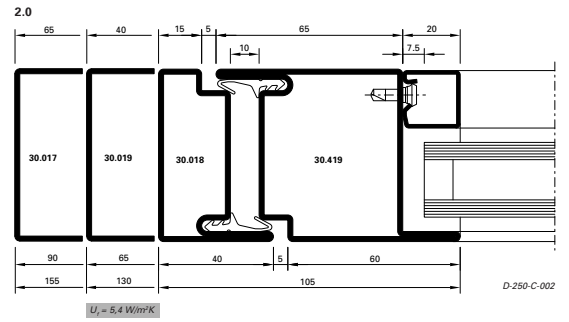

**JANSEN**

01/2014

A-62-19

Schnittpunkte im Masstab 1:1  
Coupe de détails à l'échelle 1:1  
Section details on scale 1:1

Jansen-Economy 60 Türen  
Jansen-Economy 60 portes  
Jansen-Economy 60 doors

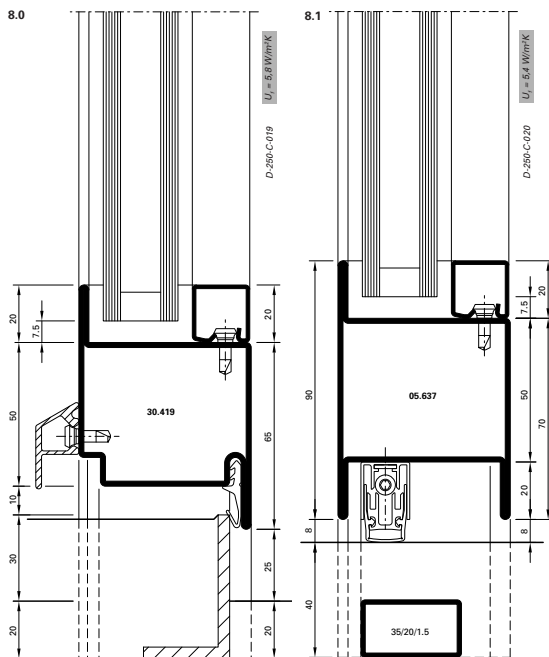

A-62-22

01/2014

**JANSEN**

Schnittpunkte im Masstab 1:1  
Coupe de détails à l'échelle 1:1  
Section details on scale 1:1

Jansen-Economy 60 Türen  
Jansen-Economy 60 portes  
Jansen-Economy 60 doors

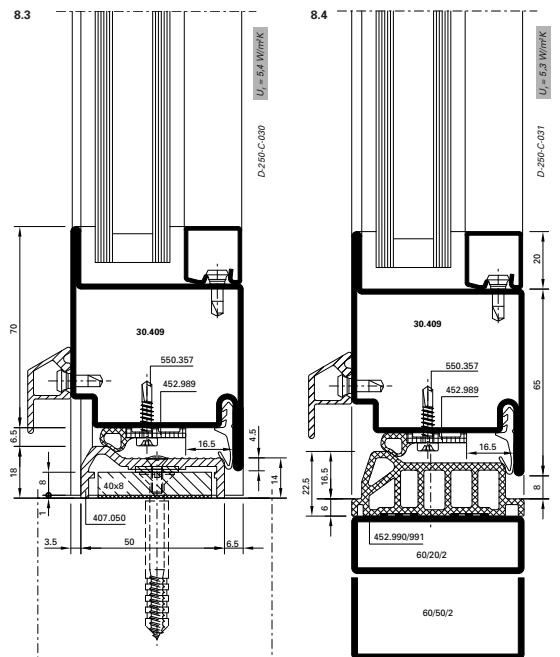

**JANSEN**

01/2014

A-62-23

# Anwendungsbeispiele

## Exemples d'application

## Examples of applications

Anwendungsbeispiele (D-250-S-001)  
 Exemples d'application (D-250-S-001)  
 Examples of applications (D-250-S-001)

Jansen-Economy 60 Türen  
 Jansen-Economy 60 portes  
 Jansen-Economy 60 doors

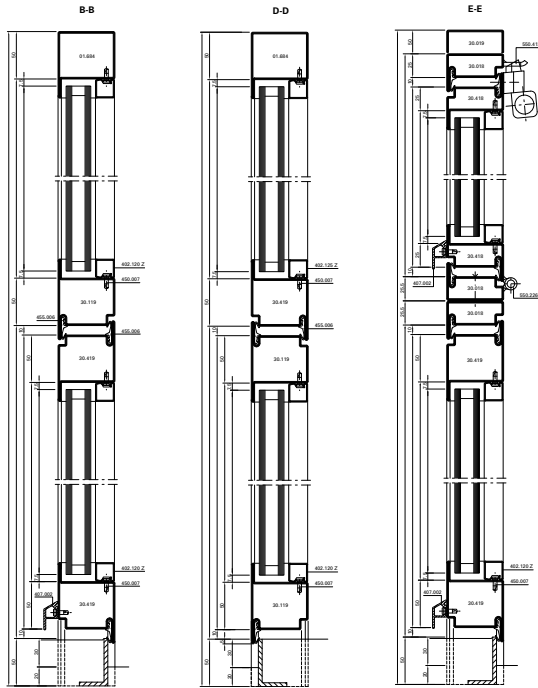

A-62-28 01/2014

**JANSEN**

Anwendungsbeispiele (D-250-S-001)  
 Exemples d'application (D-250-S-001)  
 Examples of applications (D-250-S-001)

Jansen-Economy 60 Türen  
 Jansen-Economy 60 portes  
 Jansen-Economy 60 doors

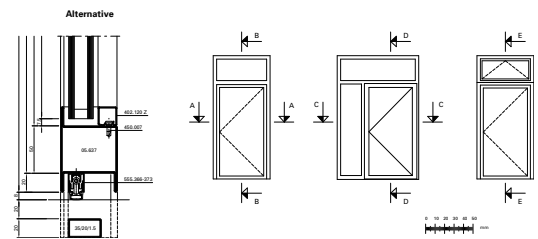
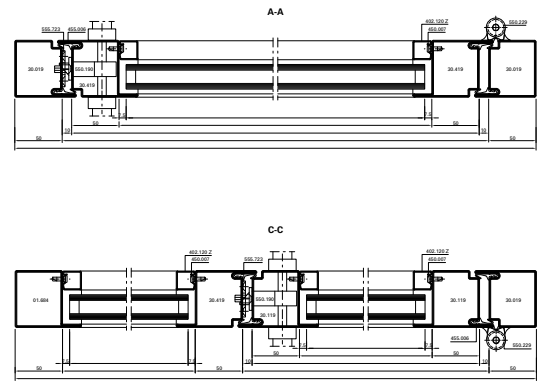

**JANSEN**

01/2014 A-62-29

Anwendungsbeispiele (D-250-S-002)  
 Exemples d'application (D-250-S-002)  
 Examples of applications (D-250-S-002)

Jansen-Economy 60 Türen  
 Jansen-Economy 60 portes  
 Jansen-Economy 60 doors

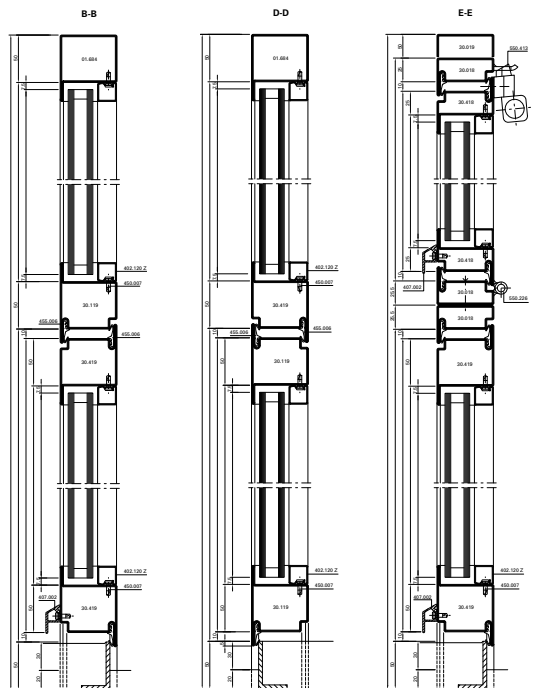

A-62-30 01/2014

**JANSEN**

Anwendungsbeispiele (D-250-S-002)  
 Exemples d'application (D-250-S-002)  
 Examples of applications (D-250-S-002)

Jansen-Economy 60 Türen  
 Jansen-Economy 60 portes  
 Jansen-Economy 60 doors

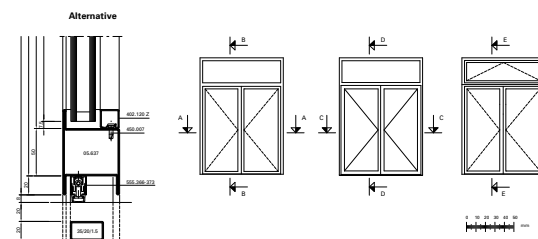
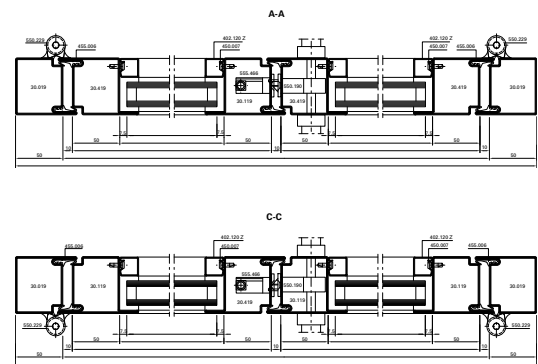

**JANSEN**

01/2014 A-62-31



Anwendungsbeispiele (D-250-S-003)  
Exemples d'application (D-250-S-003)  
Examples of applications (D-250-S-003)

Jansen-Economy 60 Türen  
Jansen-Economy 60 portes  
Jansen-Economy 60 doors

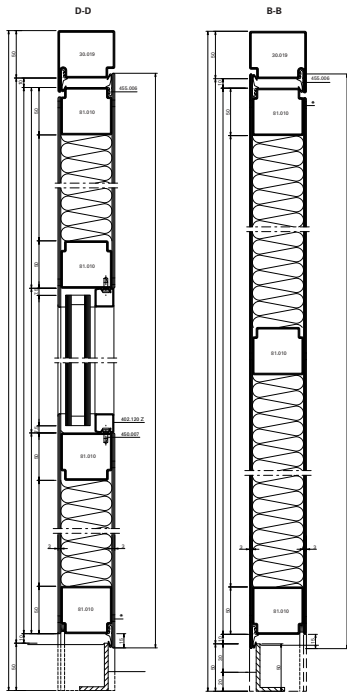

\* Hinweis Oberflächenbehandlung:  
Wegen der Lochschweißungen  
empfehlen wir eine Nasslackierung  
mit vorgängigem Spachteln.

\* Indications sur le traitement  
de surface:  
En raison des soudages en trou,  
nous recommandons un laquage  
avec vernis liquide précédé d'un  
rebouchage.

\* Surface treatment note:  
We recommend wet lacquering  
preceded by priming, due to the  
plug welds.

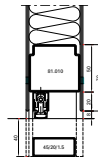

A-62-32 01/2014

**JANSEN**

Anwendungsbeispiele (D-250-S-003)  
Exemples d'application (D-250-S-003)  
Examples of applications (D-250-S-003)

Jansen-Economy 60 Türen  
Jansen-Economy 60 portes  
Jansen-Economy 60 doors

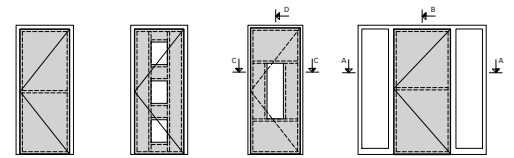
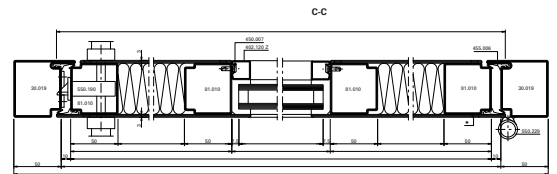
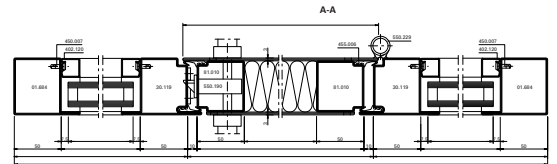

1 2 3 4 5 6 7 8 9 10 11 12 13 14 15 16 17 18 19 20 21 22 23 24 25 26 27 28 29 30 31 32 33 34 35 36 37 38 39 40 41 42 43 44 45 46 47 48 49 50 51 52 53 54 55 56 57 58 59 60 61 62 63 64 65 66 67 68 69 70 71 72 73 74 75 76 77 78 79 80 81 82 83 84 85 86 87 88 89 90 91 92 93 94 95 96 97 98 99 100

**JANSEN**

01/2014 A-62-33

Anwendungsbeispiele (D-250-C-701)  
Exemples d'application (D-250-C-701)  
Examples of applications (D-250-C-701)

Jansen-Economy 60 Türen  
Jansen-Economy 60 portes  
Jansen-Economy 60 doors

Türe durchschusshemmend FB 4 S/NS    Porte résistance aux balles FB 4 S/NS    Door bullet proofing FB 4 S/NS

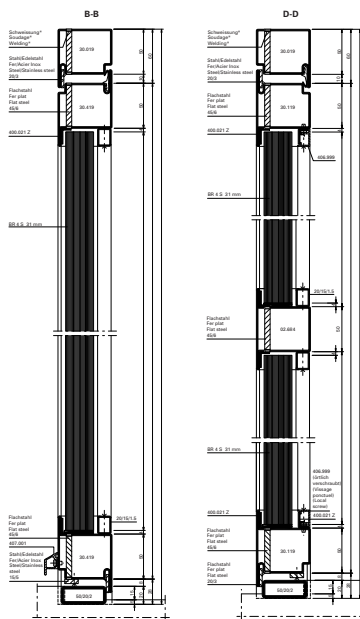

Detail E  
Türe nach innen öffnend  
Porte ouvrant vers l'intérieur  
Door inward opening

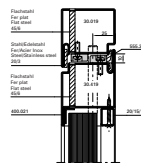

Detail E  
Türe nach außen öffnend  
Porte ouvrant vers l'extérieur  
Door outward opening

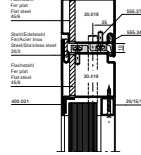

A-62-34 01/2014

**JANSEN**

Anwendungsbeispiele (D-250-C-701)  
Exemples d'application (D-250-C-701)  
Examples of applications (D-250-C-701)

Jansen-Economy 60 Türen  
Jansen-Economy 60 portes  
Jansen-Economy 60 doors

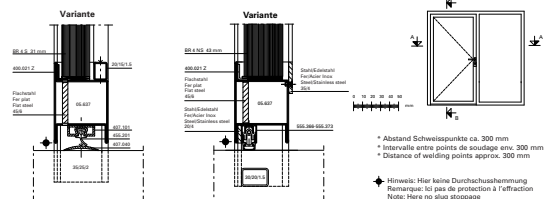
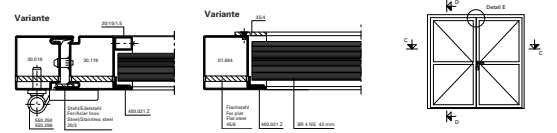
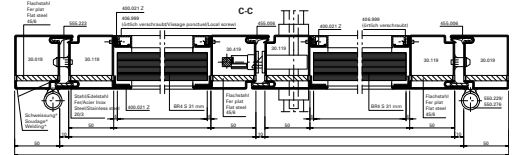
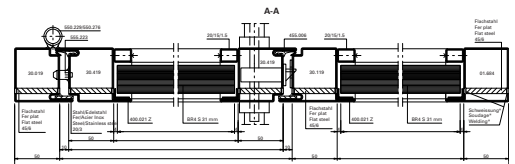

\* Abstand Schweißpunkte ca. 300 mm  
\* Intervalle entre points de soudage env. 300 mm  
\* Distance of welding points approx. 300 mm  
\* Hinweis: Hier keine Durchschusshemmung  
\* Remarque: Ici pas de protection à l'effraction  
\* Note: Here no slug stoppage

**JANSEN**

01/2014 A-62-35

# Anwendungsbeispiele

## Exemples d'application

## Examples of applications

Schnittpunkte im Masstab 1:1  
Coupe de détails à l'échelle 1:1  
Section details on scale 1:1

Economy 60 Fingerschutztüre  
Economy 60 porte anti-pince-doigts  
Economy 60 anti-finger-trap door

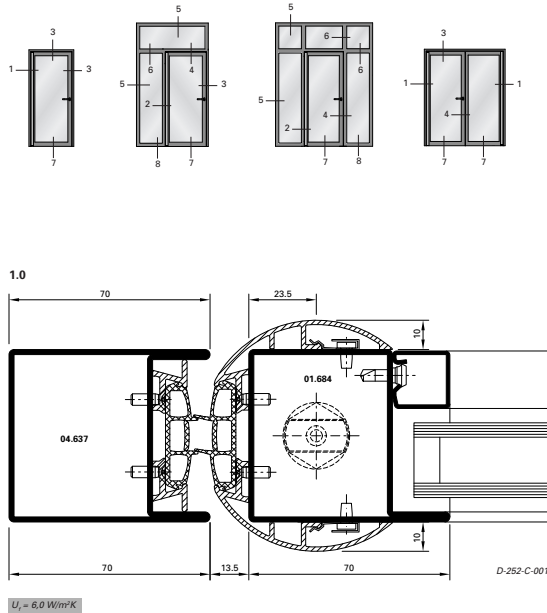

A-62-38 01/2014

**JANSEN**

Schnittpunkte im Masstab 1:1  
Coupe de détails à l'échelle 1:1  
Section details on scale 1:1

Economy 60 Fingerschutztüre  
Economy 60 porte anti-pince-doigts  
Economy 60 anti-finger-trap door

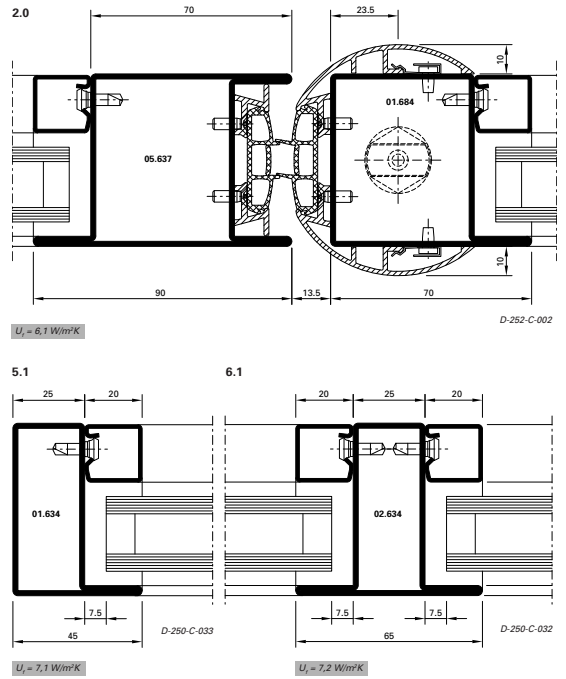

**JANSEN**

01/2014 A-62-39

Anwendungsbeispiele (D-252-S-002)  
Exemples d'application (D-252-S-002)  
Examples of applications (D-252-S-002)

Economy 60 Fingerschutztüre  
Economy 60 porte anti-pince-doigts  
Economy 60 anti-finger-trap door

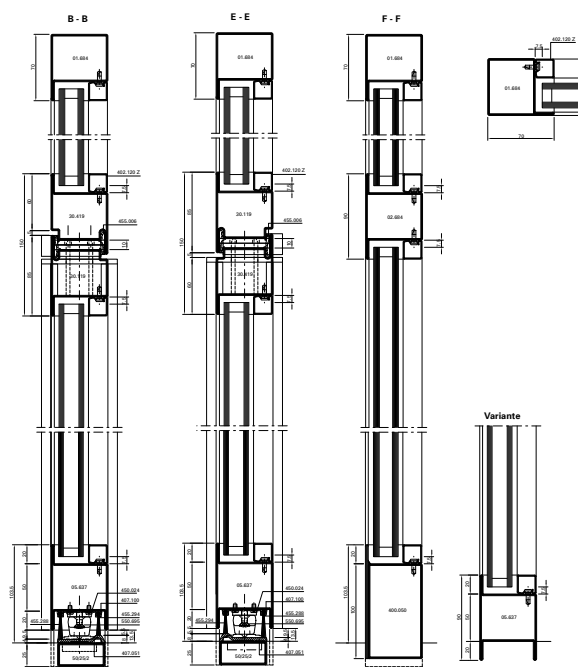

A-62-48 01/2014

**JANSEN**

Anwendungsbeispiele (D-252-S-002)  
Exemples d'application (D-252-S-002)  
Examples of applications (D-252-S-002)

Economy 60 Fingerschutztüre  
Economy 60 porte anti-pince-doigts  
Economy 60 anti-finger-trap door

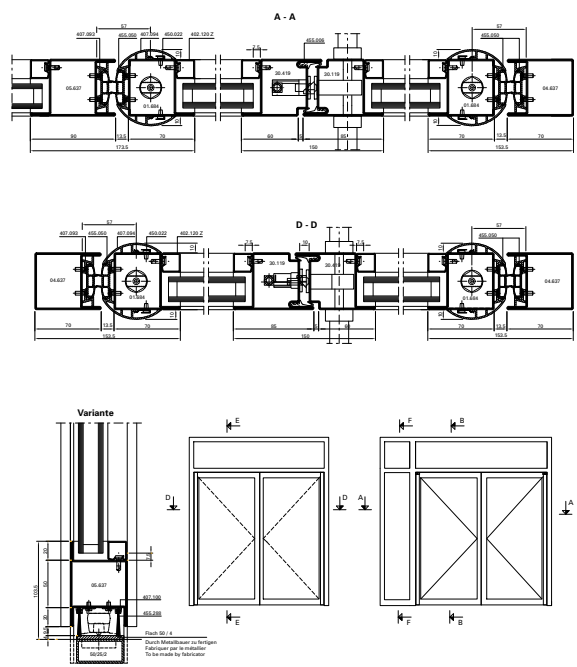

**JANSEN**

01/2014 A-62-49

Schnittpunkte im Massstab 1:1  
Coupe de détails à l'échelle 1:1  
Section details on scale 1:1

Jansen-Economy 60 Türen WK3  
Jansen-Economy 60 portes WK3  
Jansen-Economy 60 doors WK3

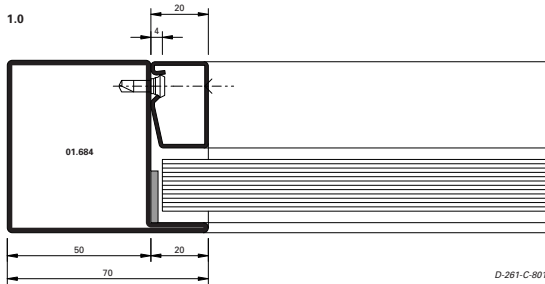
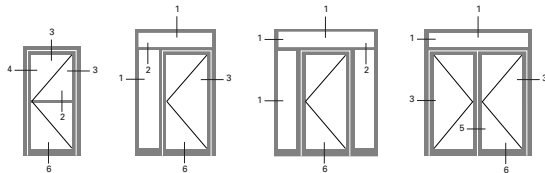

A-62-50

01/2014

**JANSEN**

Schnittpunkte im Massstab 1:1  
Coupe de détails à l'échelle 1:1  
Section details on scale 1:1

Jansen-Economy 60 Türen WK3  
Jansen-Economy 60 portes WK3  
Jansen-Economy 60 doors WK3

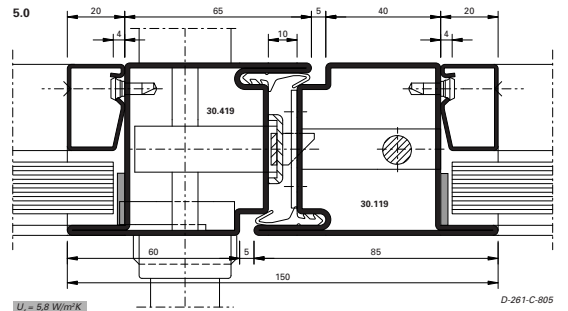
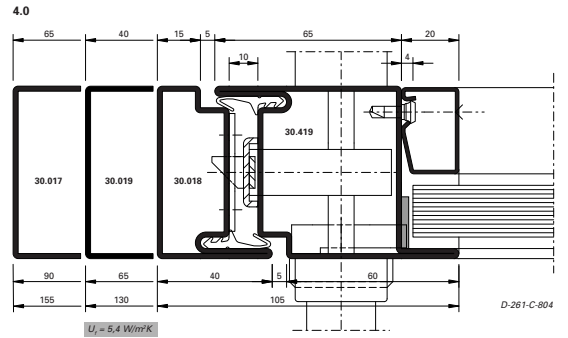

A-62-52

01/2014

**JANSEN**

Anwendungsbeispiele (D-261-S-801)  
Exemples d'application (D-261-S-801)  
Examples of applications (D-261-S-801)

Jansen-Economy 60 Türen WK3  
Jansen-Economy 60 portes WK3  
Jansen-Economy 60 doors WK3

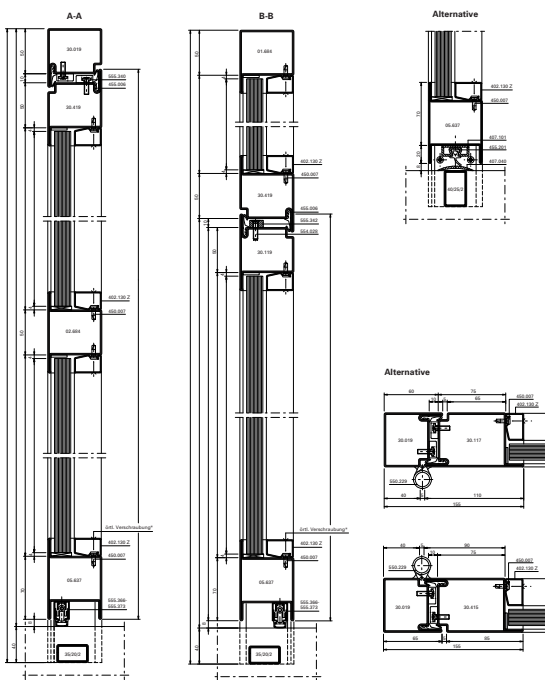

A-62-54

01/2014

**JANSEN**

Anwendungsbeispiele (D-261-S-801)  
Exemples d'application (D-261-S-801)  
Examples of applications (D-261-S-801)

Jansen-Economy 60 Türen WK3  
Jansen-Economy 60 portes WK3  
Jansen-Economy 60 doors WK3

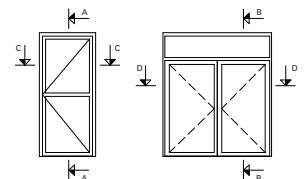
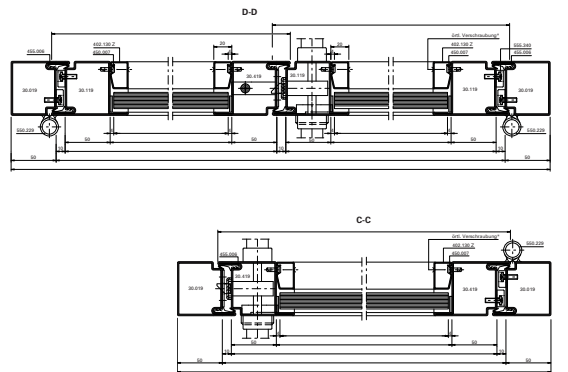

\* Zusätzliche Sicherung an den Enden und in der Mitte  
\* Sécurité complémentaire aux extrémités et au centre  
\* Additional protection at the ends and in the middle

**JANSEN**

01/2014

A-62-55

# Anschlüsse am Bau

## Raccords au mur

### Attachment to structure

Anschlüsse am Bau im Masstab 1:2  
Raccords au mur à l'échelle 1:2  
Attachment to structure on scale 1:2

Jansen-Economy 60 Türen  
Jansen-Economy 60 portes  
Jansen-Economy 60 doors

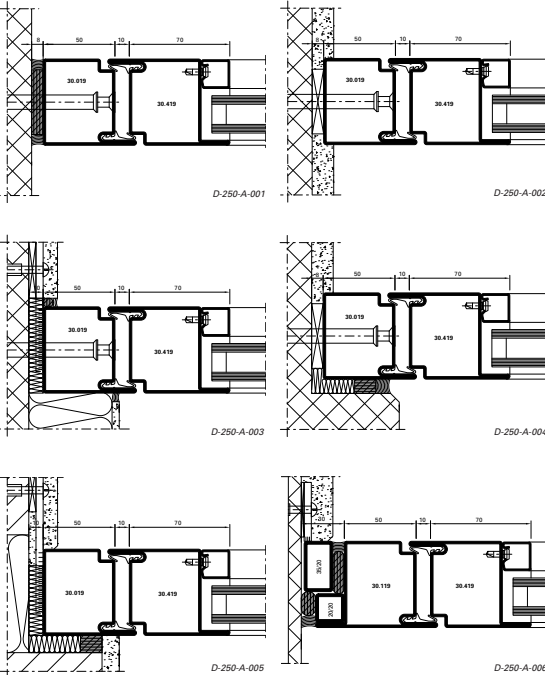

A-62-36 01/2014

**JANSEN**

Verglasungsvarianten im Masstab 1:2  
Variantes de parclozes à l'échelle 1:2  
Glazing beads options on scale 1:2

Jansen-Economy 60 Türen WK3  
Jansen-Economy 60 portes WK3  
Jansen-Economy 60 doors WK3

Glas P6B nach EN 356 (WK3)

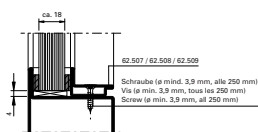

Glas P6B nach EN 356 (WK3)

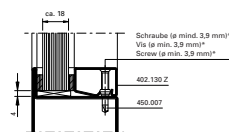

Glas P4A nach EN 356 (WK2)

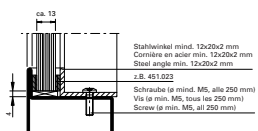

Glas P3A nach EN 356 (WK1)

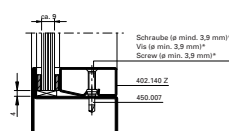

Glas P6B nach EN 356 (WK3)

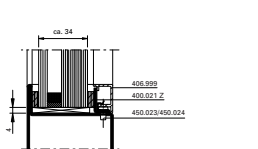

Platte / 2 x Stahlblech 2 mm  
Plaque / 2 x Tôle en acier 2 mm  
Board / 2 x Steel sheet 2 mm

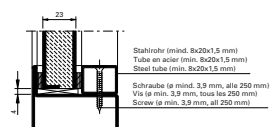

\* Zusätzliche Sicherung an den Enden und in der Mitte

\* Sécurité complémentaire aux extrémités et au centre

\* Additional protection at the ends and in the middle

A-62-56 01/2014

**JANSEN**

Anschlüsse am Bau im Masstab 1:2  
Raccords au mur à l'échelle 1:2  
Attachment to structure on scale 1:2

Jansen-Economy 60 Türen  
Jansen-Economy 60 portes  
Jansen-Economy 60 doors

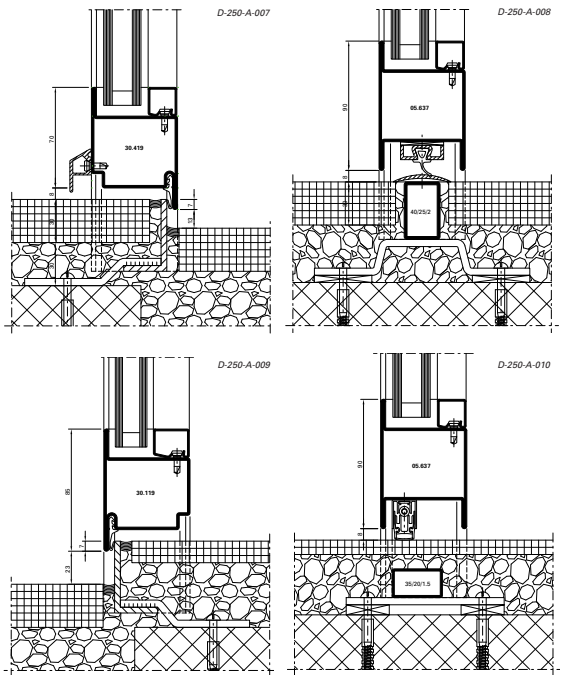

**JANSEN**

01/2014 A-62-37

Anschlüsse am Bau im Masstab 1:2  
Raccords au mur à l'échelle 1:2  
Attachment to structure on scale 1:2

Jansen-Economy 60 Türen WK3  
Jansen-Economy 60 portes WK3  
Jansen-Economy 60 doors WK3

Befestigung am Baukörper

Die Elemente können in Wände aus Mauerwerk oder Beton eingebaut werden. Je nach Widerstandsklasse sind die Vorgaben für Wände der DIN V ENV 1627 (siehe Tabelle Seite 42-231) einzuhalten.

Die Befestigung des Türelementes erfolgt mit Rahmendübeln mit einem Durchmesser von mindestens 10 mm. Wahlweise können auch Laschen zur Befestigung vorgesehen werden.

Fixation au corps de construction

Les éléments peuvent être montés sur les murs de maçonnerie ou de béton. Respecter les instructions pour les murs de norme DIN V ENV 1627 selon la classe de résistance (voir tableau page 42-231).

La fixation de l'élément de porte s'effectue au moyen de goujons de cadre d'un diamètre de 10 mm au minimum. En variante, on peut aussi prévoir des attaches pour la fixation.

Fixing to the building structure

The units can be installed in masonry or concrete walls. Depending on the resistance class, the specifications for walls in DIN V ENV 1627 must be observed (see table page 42-231).



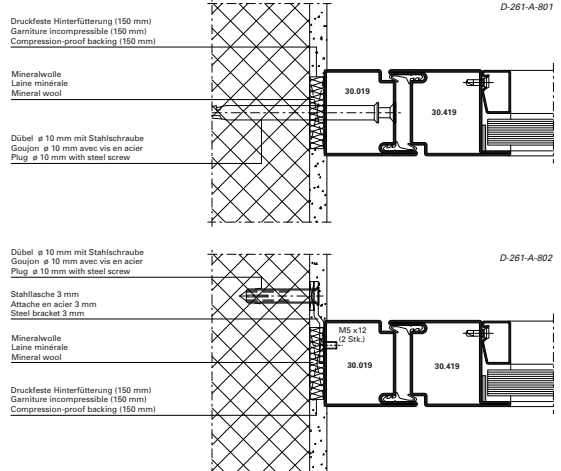





The door unit is attached using frame anchors with a diameter of 10 mm minimum. Butt straps can also be used for attaching the unit.

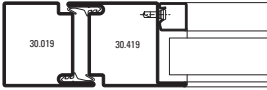
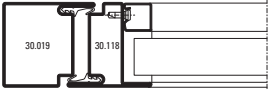
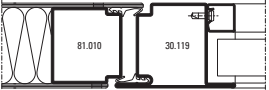
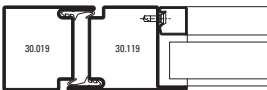
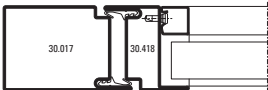
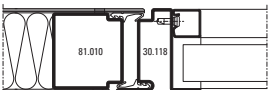
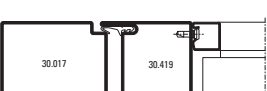
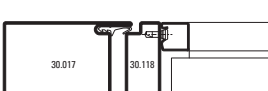
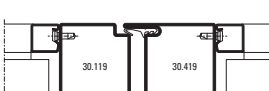
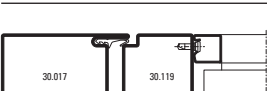
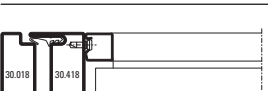
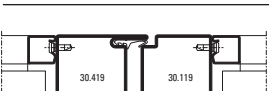

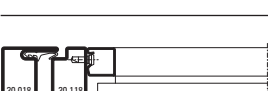
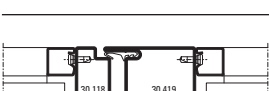
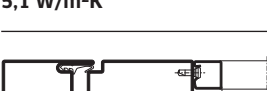
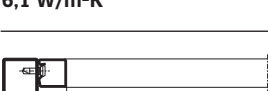
**JANSEN**

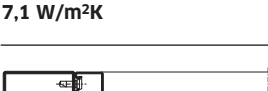
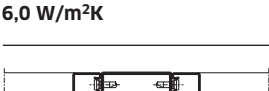
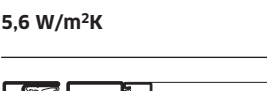
01/2014 A-62-57

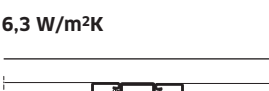
U<sub>f</sub> Werte nach EN 10077-2  
 Valeurs U<sub>f</sub> selon EN 10077-2  
 U<sub>f</sub> values according to 10077-2

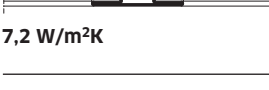
Füllelementstärken Elements de remplissages Infill elements > 24 mm	Füllelementstärken Elements de remplissages Infill elements > 24 mm	Füllelementstärken Elements de remplissages Infill elements > 24 mm
 5,4 W/m <sup>2</sup> K	 5,8 W/m <sup>2</sup> K	 5,7 W/m <sup>2</sup> K
 5,5 W/m <sup>2</sup> K	 5,4 W/m <sup>2</sup> K	 6,0 W/m <sup>2</sup> K
 5,2 W/m <sup>2</sup> K	 5,5 W/m <sup>2</sup> K	 5,8 W/m <sup>2</sup> K
 5,3 W/m <sup>2</sup> K	 6,0 W/m <sup>2</sup> K	 5,8 W/m <sup>2</sup> K
 5,1 W/m <sup>2</sup> K	 6,1 W/m <sup>2</sup> K	 6,1 W/m <sup>2</sup> K
 5,2 W/m <sup>2</sup> K	 7,1 W/m <sup>2</sup> K	 6,0 W/m <sup>2</sup> K
 5,6 W/m <sup>2</sup> K	 6,0 W/m <sup>2</sup> K	 6,3 W/m <sup>2</sup> K
 5,6 W/m <sup>2</sup> K	 5,3 W/m <sup>2</sup> K	 7,2 W/m <sup>2</sup> K
 5,7 W/m <sup>2</sup> K	 5,3 W/m <sup>2</sup> K	 6,8 W/m <sup>2</sup> K

# U<sub>f</sub> Werte nach EN 10077-2

## Valeurs U<sub>f</sub> selon EN 10077-2

### U<sub>f</sub> values according to 10077-2

Füllelementstärken  
Elements de remplissages  
Infill elements

> 24 mm

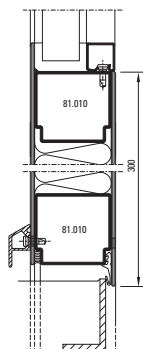

4,4 W/m<sup>2</sup>K

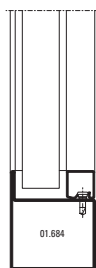

6,0 W/m<sup>2</sup>K

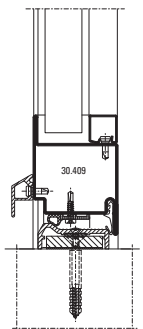

5,4 W/m<sup>2</sup>K

Füllelementstärken  
Elements de remplissages  
Infill elements

> 24 mm

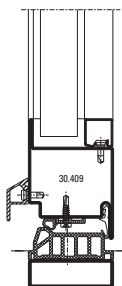

5,3 W/m<sup>2</sup>K

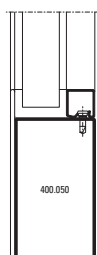

5,2 W/m<sup>2</sup>K

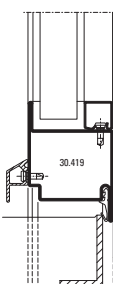

5,8 W/m<sup>2</sup>K

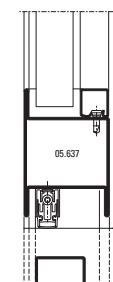

5,4 W/m<sup>2</sup>K

Die Werte gelten für Trocken- und Nassverglasung.

Les valeurs sont valables pour vitrage à sec et vitrage à mastic.

The values are valid for dry glazing and glazing with sealing.

Leistungswerte  
Valeurs de performance  
Performance values

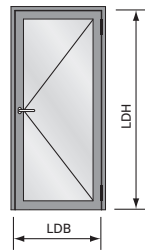





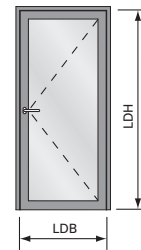

Auswärts öffnend  
Ouvrant vers l'extérieur  
Outward opening

**LDB = 1300 mm**  
**LDH = 2800 mm**



Einwärts öffnend  
Ouvrant vers l'intérieur  
Inward opening

**LDB = 1300 mm**  
**LDH = 2800 mm**

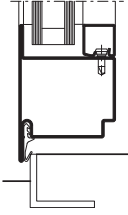
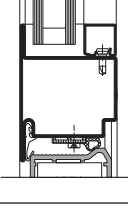
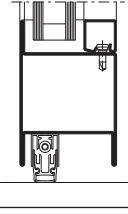
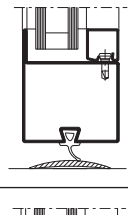
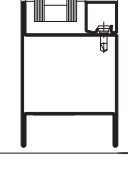
	 <b>EN 12208</b>	 <b>EN 12207</b>	 <b>EN 12210</b>	 <b>EN 12208</b>	 <b>EN 12207</b>	 <b>EN 12210</b>
Größenänderungen Variations dimensionnelles Size changes	-100%	-100%	-100%	-100%	-100%	-100%
	Klasse 0 Classe 0 Class 0	Klasse 2 Classe 2 Class 2	Klasse C2 Classe C2 Class C2	Klasse 0 Classe 0 Class 0	Klasse 2 Classe 2 Class 2	Klasse C2 Classe C2 Class C2
	Klasse 2A Classe 2A Class 2A	Klasse 2 Classe 2 Class 2	Klasse C2 Classe C2 Class C2	Klasse 0 Classe 0 Class 0	Klasse 2 Classe 2 Class 2	Klasse C2 Classe C2 Class C2
	Klasse 0 Classe 0 Class 0	Klasse 2 Classe 2 Class 2	Klasse C2 Classe C2 Class C2	Klasse 0 Classe 0 Class 0	Klasse 2 Classe 2 Class 2	Klasse C2 Classe C2 Class C2
	Klasse 0 Classe 0 Class 0	Klasse 1 Classe 1 Class 1	Klasse C2 Classe C2 Class C2	Klasse 0 Classe 0 Class 0	Klasse 1 Classe 1 Class 1	Klasse C2 Classe C2 Class C2
	npd	npd	npd	npd	npd	npd

# Leistungswerte

## Valeurs de performance



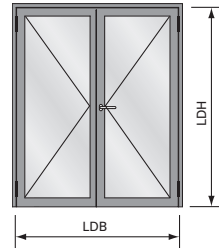

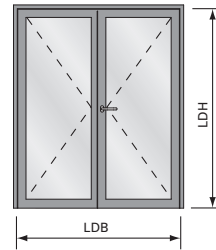

### Performance values



Auswärts öffnend  
Ouvrant vers l'extérieur  
Outward opening  
**LDB = 2600 mm**  
**LDH = 2800 mm**

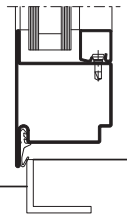
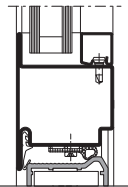
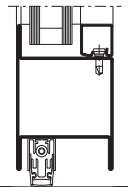
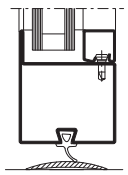
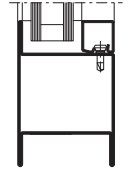

Einwärts öffnend  
Ouvrant vers l'intérieur  
Inward opening  
**LDB = 2600 mm**  
**LDH = 2800 mm**

	 <b>EN 12208</b>	 <b>EN 12207</b>	 <b>EN 12210</b>	 <b>EN 12208</b>	 <b>EN 12207</b>	 <b>EN 12210</b>
Größenänderungen Variations dimensionnelles Size changes	-100%	-100%	-100%	-100%	-100%	-100%
	Klasse 0 Classe 0 Class 0	Klasse 1 Classe 1 Class 1	Klasse C2 Classe C2 Class C2	Klasse 0 Classe 0 Class 0	Klasse 1 Classe 1 Class 1	Klasse C2 Classe C2 Class C2
	Klasse 1A Classe 1A Class 1A	Klasse 1 Classe 1 Class 1	Klasse C2 Classe C2 Class C2	Klasse 0 Classe 0 Class 0	Klasse 1 Classe 1 Class 1	Klasse C2 Classe C2 Class C2
	Klasse 0 Classe 0 Class 0	Klasse 1 Classe 1 Class 1	Klasse C2 Classe C2 Class C2	Klasse 0 Classe 0 Class 0	Klasse 1 Classe 1 Class 1	Klasse C2 Classe C2 Class C2
	Klasse 0 Classe 0 Class 0	Klasse 1 Classe 1 Class 1	Klasse C2 Classe C2 Class C2	Klasse 0 Classe 0 Class 0	Klasse 1 Classe 1 Class 1	Klasse C2 Classe C2 Class C2
	npd	npd	npd	npd	npd	npd